







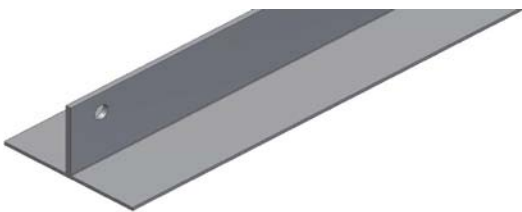
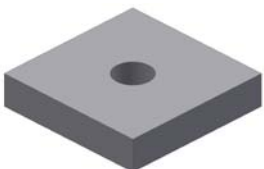

Držiak pre slnečný kolektor KPG1 naležato

/ Support bracket for KPG1 solar collector, for horizontal installations

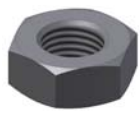
Rovná strecha - trojuholníková podpera 45° kód 10921 / Flat roof - triangle bracket 45° code 10921

Obrázok Fig.	Označenie Name	Rozmer Dimensions	Množstvo Qty	Kód dielu Code
	Profil "L" 30x30x3 - hliník / L-beam 30x30x3 in aluminum	Dĺžka 1100 mm / Length 1100 mm	1 ks / 1 piece	9470
	Profil základný "H"- hliník / Basic H-beam in aluminum	Dĺžka 790 mm / Length 790 mm	1 ks / 1 piece	6949
	Profil základný "T" č.12197 - hliník / T- beam no.12197 in aluminium	Dĺžka 790 mm / Length 790 mm	1 ks / 1 piece	9469
	Podložka držiaka Al /Square washer for collector support, aluminum	32x32 hr. 8 mm / 32x32, 8 mm thick	2 ks / 2 pcs	9405
	Skrutka M8x45 nerez (imbus) DIN 912/A2 / Socket screw M8x45, stainless steel DIN 912/A2	M8x45	2 ks / 2 pcs	9564
	Skrutka M8x16 nerez (imbus) DIN 912/A2 / Socket screw M8x16, stainless steel DIN 912/A2	M8x16	1 ks / 1 piece	6926
	Matica M8 nerez DIN 934/A2 / M8 Hex nut, stainless steel DIN 934/A2	M8	5 ks / 5 pcs	8381
	Podložka 8,4 nerez DIN 125/A2 / 8.4 Flat washer, stainless steel DIN 125/A2	pr.8,4 mm / diam. 8.4 mm	3 ks / 3 pcs	7256
	Podložka vejárová - vonkajšie ozubenie 8,4 DIN 6798 A/A2 nerez /Serrated tooth washer, 8.4, DIN6798 A/A2, stainless steel	pr.8,4 mm / diam. 8.4 mm	5 ks / 5 pcs	8382
	Skrutka M8x30 veľká hlava - pre základný profil / M8x30 bolt with big T head, for H-beam	M8x30	2 ks / 2 pcs	8369
	Krytka H profilu / H- rail end plug		1 ks / 1 piece	11373

Zostavenie držiakov pre slnečné kolektory KPG1, pre rovné strechy - zvýšenie uhla o 45°.

Assembly of triangle brackets for KPG1 solar collectors, for flat roofs-angle increase by 45°.

Po rozbalení
Unpacking

Rozložiť
Unfolding

Zoskrutkovať
Joining together

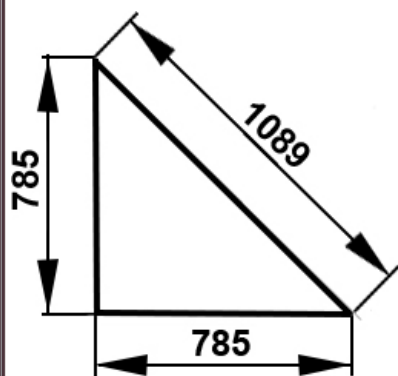
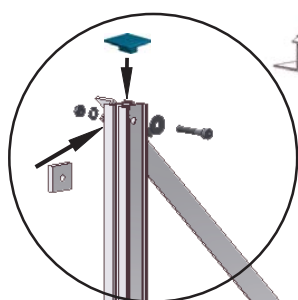

Všetky spoje starostlivo dotiahnite!
Tighten all connections meticulously!