

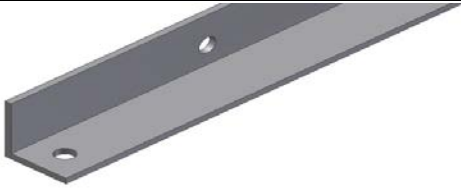







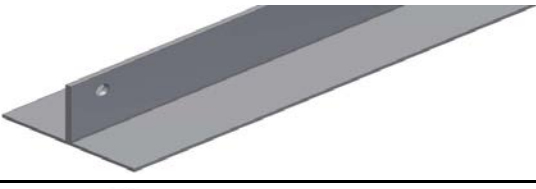
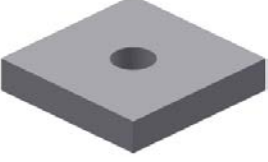

## Držiak pre slnečný kolektor KPG1H naležato

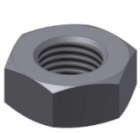
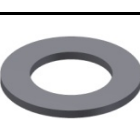
/ Support bracket for KPG1H solar collector, for horizontal installations

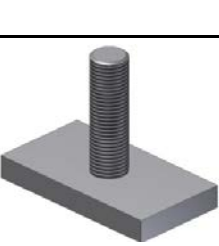
Na stenu - trojuholníková podpera 15° kód 14792 / Wall mount triangle bracke 15° code 14792

Obrázok Fig.	Označenie Name	Rozmer Dimensions	Množstvo Qty	Kód diela Code
	<b>Profil "L" 30x30x3 - hliník</b> / L-beam 30x30x3 in aluminum	<b>Dĺžka 1124 mm</b> / Length 1124 mm	<b>1 ks / 1 piece</b>	<b>9470</b>
	<b>Profil základný "H"-hliník</b> / Basic H-beam in aluminum	<b>Dĺžka 322 mm</b> / Length 322 mm	<b>1 ks / 1 piece</b>	<b>11095</b>
	<b>Profil základný "T" č.12197 - hliník</b> / T-beam no.12197 in aluminium	<b>Dĺžka 1122 mm</b> / Length 1122 mm	<b>1 ks / 1 piece</b>	<b>9469</b>
	<b>Podložka držiakov Al</b> / Square washer for collector support, aluminum	<b>32x32 hr. 8 mm</b> / 32x32, 8 mm thick	<b>2 ks / 2 pcs</b>	<b>9405</b>
	<b>Skrutka M8x45 nerez (imbus) DIN 912/A2</b> / Socket screw M8x45, stainless steel DIN 912/A2	<b>M8x45</b>	<b>2 ks / 2 pcs</b>	<b>9564</b>
	<b>Skrutka M8x16 nerez (imbus) DIN 912/A2</b> / Socket screw M8x16, stainless steel DIN 912/A2	<b>M8x16</b>	<b>1 ks / 1 piece</b>	<b>6926</b>
	<b>Matica M8 nerez DIN 934/A2</b> / M8 Hex nut, stainless steel DIN 934/A2	<b>M8</b>	<b>5 ks / 5 pcs</b>	<b>8381</b>
	<b>Podložka 8,4 nerez DIN 125/A2</b> / 8.4 Flat washer, stainless steel DIN 125/A2	<b>pr.8,4 mm / diam. 8.4 mm</b>	<b>3 ks / 3 pcs</b>	<b>7256</b>
	<b>Podložka vejárová - vonkajšie ozubenie 8,4 DIN 6798 A/A2 nerez</b> / Serrated tooth washer, 8.4, DIN6798 A/A2, stainless steel	<b>pr.8,4 mm / diam. 8.4 mm</b>	<b>5 ks / 5 pcs</b>	<b>8382</b>
	<b>Skrutka M8x30 veľká hlava - pre základný profil</b> / M8x30 bolt with big T head, for H-beam	<b>M8x30</b>	<b>2 ks / 2 pcs</b>	<b>8369</b>
	<b>Krytka H profilu</b> / H-rail end plug		<b>1 ks / 1 piece</b>	<b>11773</b>
	<b>Vrut 8x75 nerez (6hr. hlava) DIN 571/A2</b> / 8x75 Lag bolt, stainless steel, DIN 571/A2	<b>pr.8x75 mm / diam. 8x75 mm</b>	<b>5 ks / 5 pcs</b>	<b>12787</b>
	<b>Podložka 8,4 (veľká 3d) nerez DIN 9021/A2</b> / Washer 8.4 (large diam. 3d), stainless steel, DIN 9021/A2	<b>pr.8,4 mm / diam. 8.4 mm</b>	<b>5 ks / 5 pcs</b>	<b>7008</b>
	<b>Hmoždinka pr. 12</b> / Dowel, 12mm	<b>pr.12 mm / diam. 12 mm</b>	<b>5 ks / 5 pcs</b>	<b>11893</b>

## Zostavenie držiakov pre slnečné kolektory

### KPG1H, naležato 15°, na stenu.

Assembly of triangle brackets for KPG1H solar collectors,  
for horizontal installations 15°, on the wall

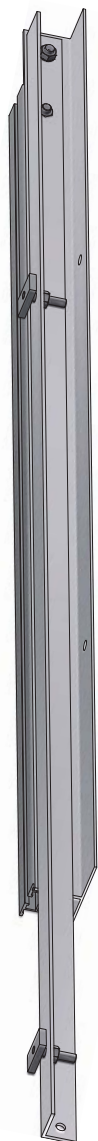

Po rozbalení  
Unpacking

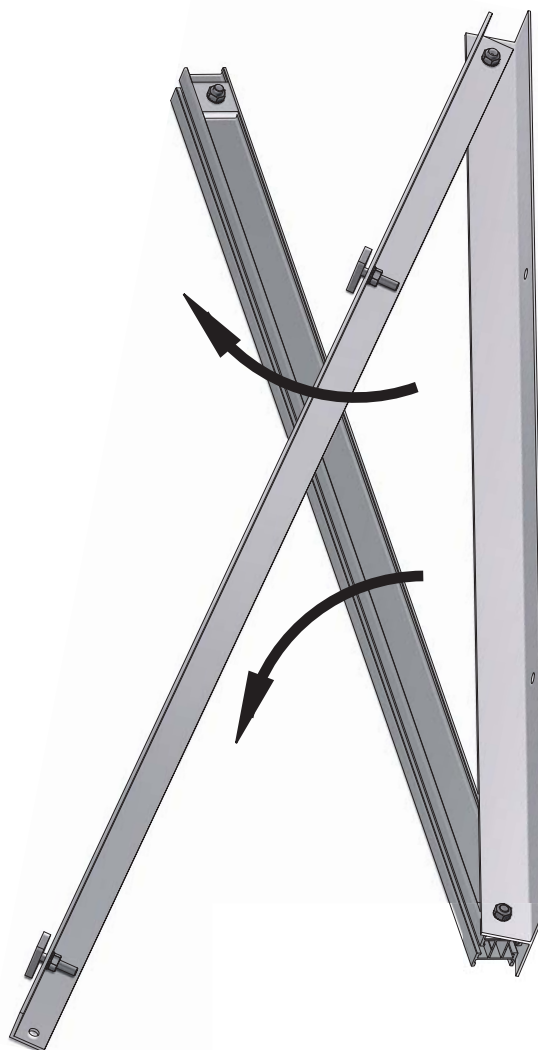

Rozložit'  
Unfolding

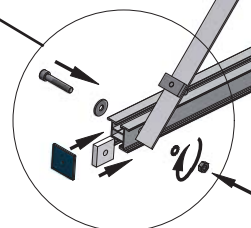
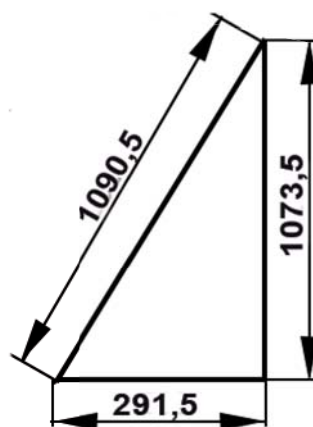
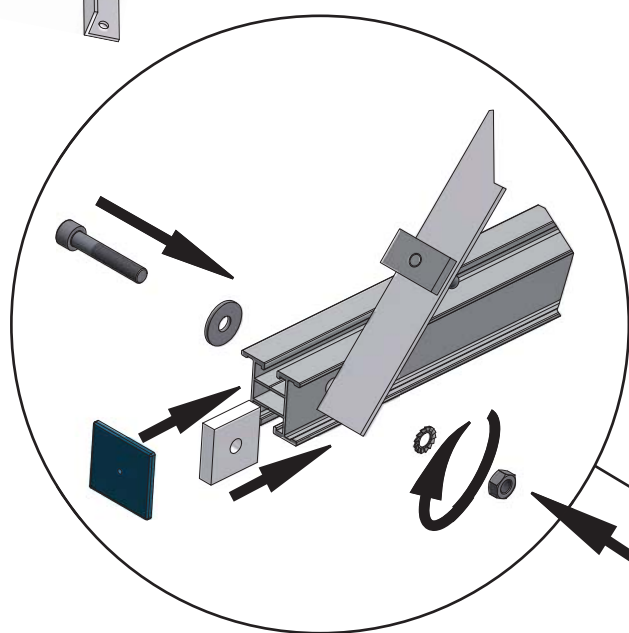

Všetky spoje starostlivo dotiahnut!  
Tighten all connections meticulously!

Zoskrutkovať  
Joining together