

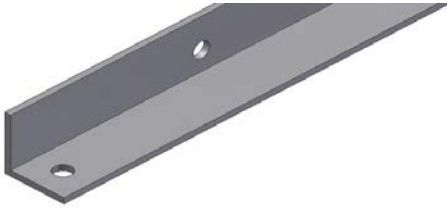





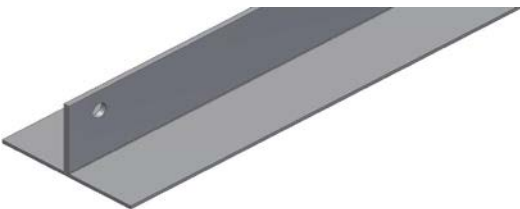
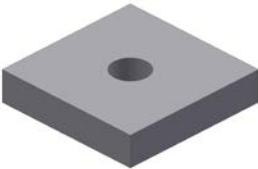

## Držiak pre slnečný kolektor KPG1 na ležato

/ Support bracket for KPG1 solar collector, for horizontal installations

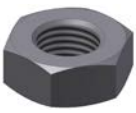
Rovná strecha - trojuholníková podpera 25° kód 10907 / Flat roof - triangle bracket 25° code 10907

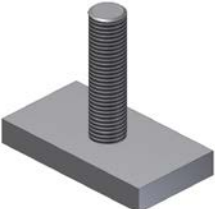
Obrázok Fig.	Označenie Name	Rozmer Dimensions	Množstvo Qty	Kód diela Code
	<b>Profil "L" 30x30x3</b> - hliník / L-beam 30x30x3 in aluminum	<b>Dĺžka 1110</b> mm / Length 1110 mm	<b>1 ks / 1 piece</b>	<b>9470</b>
	<b>Profil základný "H"-</b> hliník / Basic H-beam in aluminum	<b>Dĺžka 490</b> mm / Length 490 mm	<b>1 ks / 1 piece</b>	<b>6949</b>
	<b>Profil základný</b> "T" č.12197 - hliník / T-beam no.12197 in aluminium	<b>Dĺžka 1050</b> mm / Length 1050 mm	<b>1 ks / 1 piece</b>	<b>9469</b>
	<b>Podložka držiaka</b> Al /Square washer for collector support, aluminum	<b>32x32 hr. 8</b> mm / 32x32, 8 mm thick	<b>2 ks /2 pcs</b>	<b>9405</b>
	<b>Skrutka M8x45</b> nerez (imbus) DIN 912/A2 / Socket screw M8x45, stainless steel DIN 912/A2	<b>M8x45</b>	<b>2 ks /2 pcs</b>	<b>9564</b>
	<b>Skrutka M8x16 nerez</b> (imbus) DIN 912/A2 / Socket screw M8x16, stainless steel DIN 912/A2	<b>M8x16</b>	<b>1 ks / 1 piece</b>	<b>6926</b>
	<b>Matica M8 nerez</b> DIN 934/A2 / M8 Hex nut, stainless steel DIN 934/A2	<b>M8</b>	<b>5 ks /5 pcs</b>	<b>8381</b>
	<b>Podložka 8,4 nerez</b> DIN 125/A2 / 8.4 Flat washer, stainless steel DIN 125/A2	<b>pr.8,4 mm /</b> diam. 8.4 mm	<b>3 ks /3 pcs</b>	<b>7256</b>
	<b>Podložka vejárová</b> - vonkajšie ozubenie 8,4 DIN 6798 A/A2 nerez /Serrated tooth washer, 8.4, DIN6798 A/A2, stainless steel	<b>pr.8,4 mm /</b> diam. 8.4 mm	<b>5 ks /5 pcs</b>	<b>8382</b>
	<b>Skrutka M8x30 veľká</b> hlava - pre základný profil / M8x30 bolt with big T head, for H-beam	<b>M8x30</b>	<b>2 ks /2 pcs</b>	<b>8369</b>
	<b>Krytka H profilu / H-</b> rail end plug		<b>1 ks / 1 piece</b>	<b>11773</b>

# Zostavenie držiakov pre slnečné kolektory KPG1, pre rovné strechy - zvýšenie uhla o 25°.

Assembly of triangle brackets for KPG1 solar collectors, for flat roofs-angle increase by 25°.

Po rozbalení  
Unpacking

Rozložiť  
Unfolding

Zoskrutkovať  
Joining together

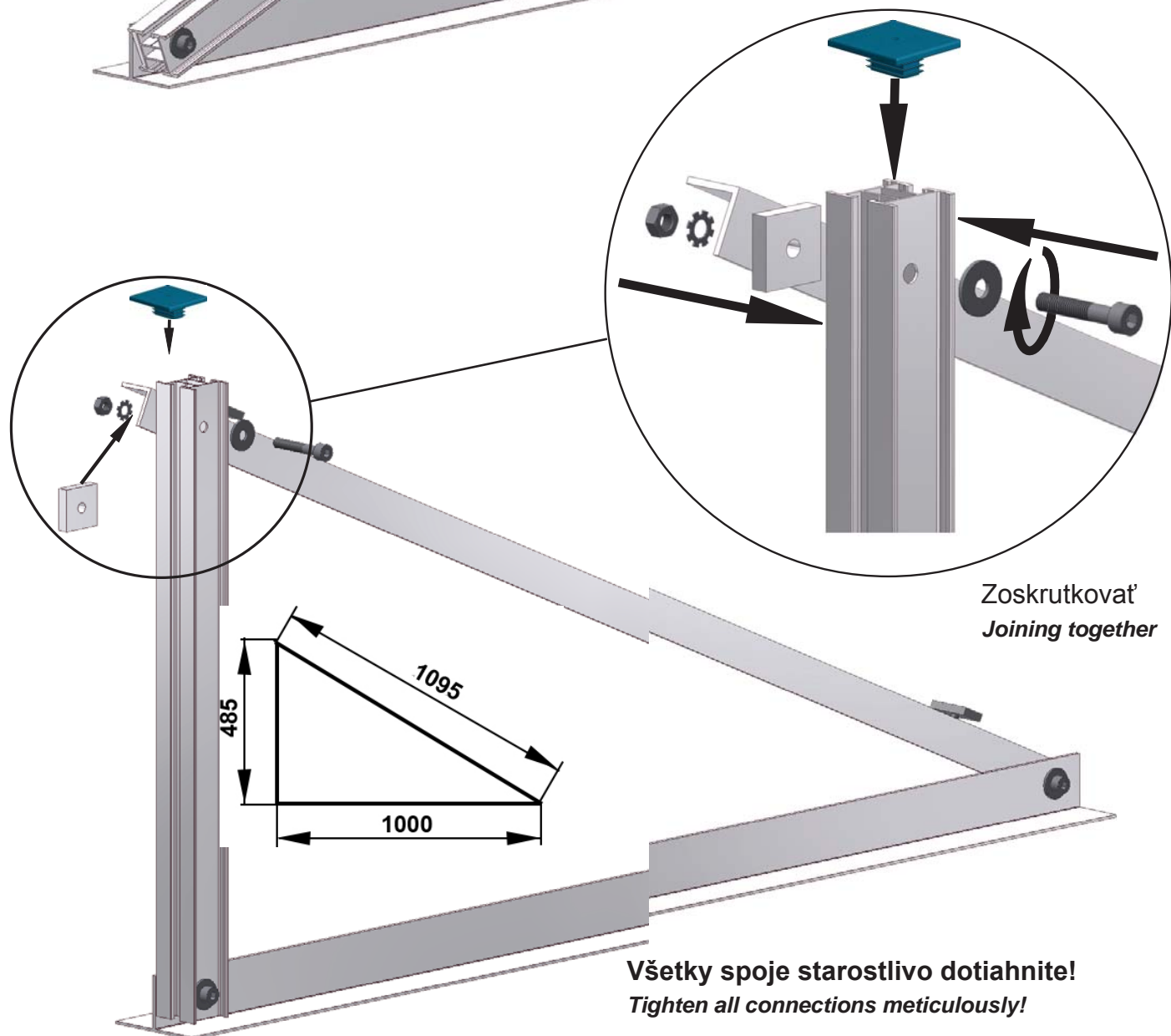

Všetky spoje starostlivo dotiahnite!  
Tighten all connections meticulously!