

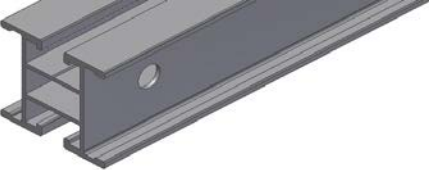

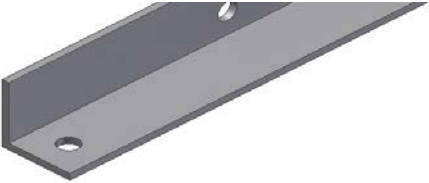



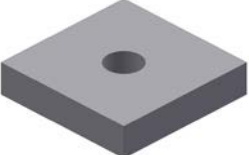

## Držiak pre úpravu sklona kolektorov KPG1 naležato

*Support bracket for KPG1 inclination adjustment, for horizontal installations*

(vhodné na háky do šikmých striech) **Uhol 25° - kód 11071**

(suitable for sloping roof anchors) **25 degree angle - code 11071**

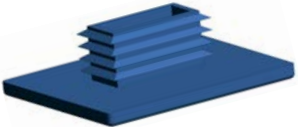
Obrázok Fig.	Označenie Name	Rozmer Dimensions	Množstvo Qty	Kód diela Code
	<b>Profil základný "H"-hliník / Basic H-beam in aluminum</b>	<b>Dĺžka 460 mm / Length 460 mm</b>	<b>1 ks / 1 piece</b>	<b>6949</b>
	<b>Profil "L" 30×30×3 - hliník / L-beam 30×30×3 in aluminum</b>	<b>Dĺžka 1100 mm / Length 1100 mm</b>	<b>1 ks / 1 piece</b>	<b>9470</b>
	<b>Profil základný "H"-hliník / Basic H-beam in aluminum</b>	<b>Dĺžka 1000 mm / Length 1000 mm</b>	<b>1 ks / 1 piece</b>	<b>6949</b>
	<b>Matica pre držiak kolektora / Special nut for collector support</b>	<b>M8</b>	<b>1 ks / 1 piece</b>	<b>11155</b>
	<b>Podložka držiaka Al / Square washer for collector support, aluminum</b>	<b>32×32 hr. 8 mm / 32×32, 8 mm thick</b>	<b>2 ks / 2 pcs</b>	<b>9405</b>
	<b>Skrutka M8×50 nerez (imbus) DIN 912/A2 / Socket screw M8×50, stainless steel DIN 912/A2</b>	<b>M8×50</b>	<b>2 ks / 2 pcs</b>	<b>9982</b>
	<b>Skrutka M8×80 nerez (imbus) DIN 912/A2 / Socket screw M8×80, stainless steel DIN 912/A2</b>	<b>M8×80</b>	<b>1 ks / 1 piece</b>	<b>11156</b>
	<b>Podložka 8,4 nerez DIN 125/A2 / 8.4 Flat washer, stainless steel DIN 125/A2</b>	<b>pr.8,4 mm / diam. 8.4 mm</b>	<b>7 ks / 7 pcs</b>	<b>7256</b>
	<b>Matica M8 nerez DIN 934/A2 / M8 Hex nut, stainless steel DIN 934/A2</b>	<b>M8</b>	<b>4 ks / 4 pcs</b>	<b>8381</b>
	<b>Skrutka M8×30 veľká hlava - pre základný profil / M8x30 bolt with big T head, for H-beam</b>	<b>M8×30</b>	<b>2 ks / 2 pcs</b>	<b>8369</b>
	<b>Podložka vejárová - vonkajšie ozubenie 8,4 DIN 6798 A/A2 nerez / Serrated tooth washer, 8.4, DIN6798 A/A2, stainless steel</b>	<b>pr.8,4 mm / diam. 8.4 mm</b>	<b>5 ks / 5 pcs</b>	<b>8382</b>
	<b>Krytka H profilu / H-rail end plug</b>		<b>3 ks / 3 pcs</b>	<b>11773</b>

# Zostavenie držiakov pre slnečné kolektory KPG1 naležato, pre šikmé strechy - zvýšenie uhla o 25°.

Assembly of triangle brackets for KPG1 solar collectors,  
for horizontal installations, for sloping roofs - angle  
increase by 25°.

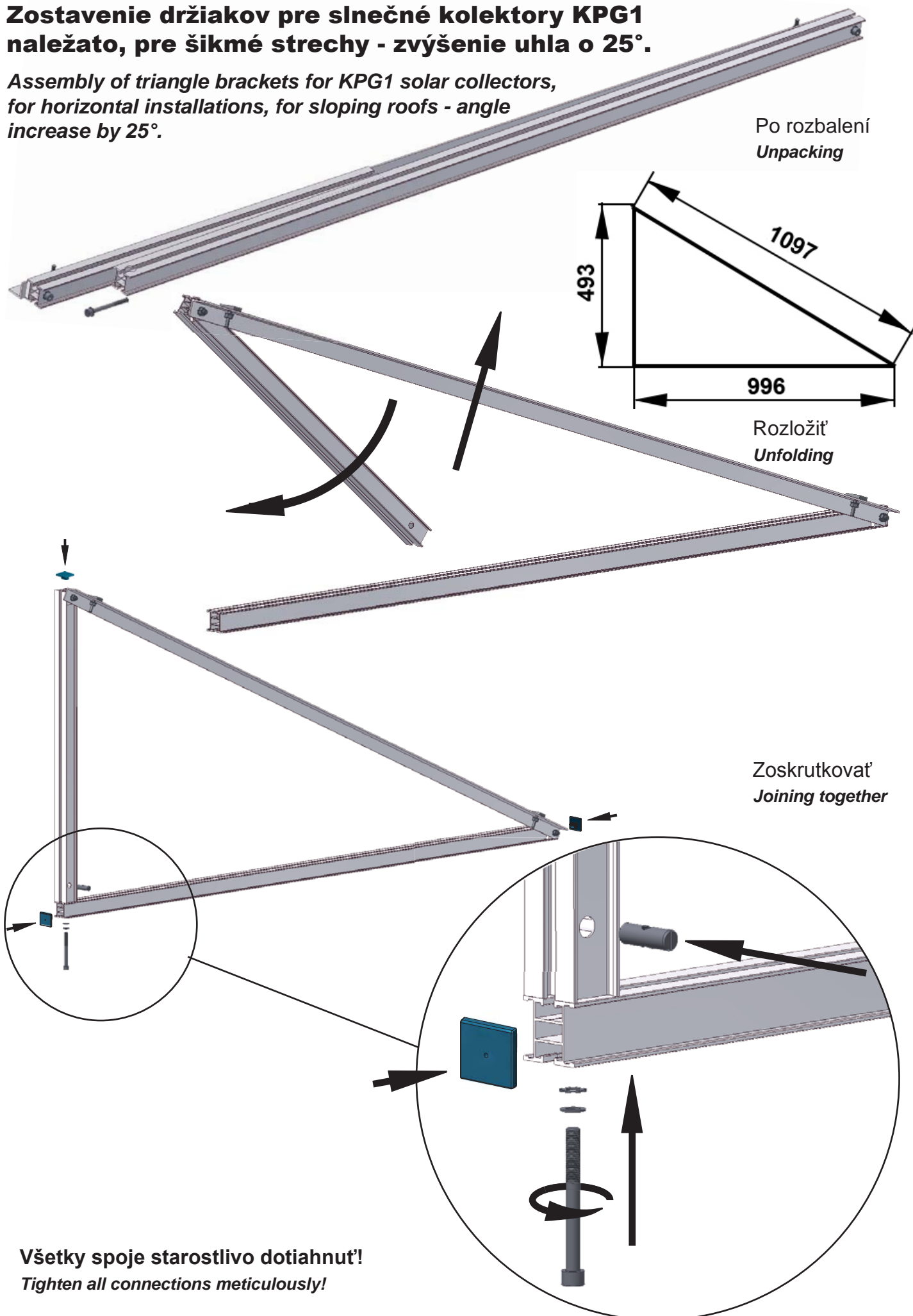

**Všetky spoje starostlivo dotiahnuť!**  
*Tighten all connections meticulously!*