

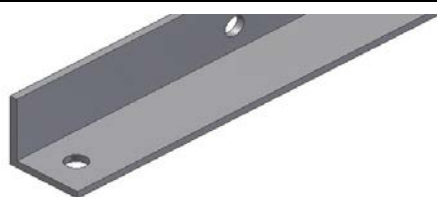





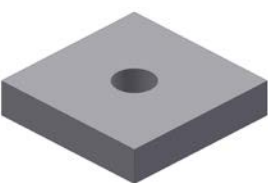

## Držiak pre úpravu sklona kolektorov KPG1 naležato

*Support bracket for KPG1 inclination adjustment, for horizontal installations*

(vhodné na háky do šikmých striech) **Uhol 45° - kód 11072**

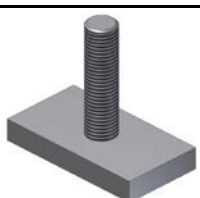
*(suitable for sloping roof anchors) 45 degree angle - code 11072*

Obrázok Fig.	Označenie Name	Rozmer Dimensions	Množstvo Qty	Kód diela Code
	Profil základný "H"- hliník / Basic H-beam in aluminum	Dĺžka 760 mm / Length 760 mm	1 ks / 1 piece	<b>6949</b>
	Profil "L" 30×30×3 hliník / L-beam 30×30×3 in aluminum	Dĺžka 1100 mm / Length 1100 mm	1 ks / 1 piece	<b>9470</b>
	Profil základný "H"- hliník / Basic H-beam in aluminum	Dĺžka 800 mm / Length 800 mm	1 ks / 1 piece	<b>6949</b>
	Matica pre držiak kolektora / Special nut for collector support	<b>M8</b>	1 ks / 1 piece	<b>11155</b>
	Podložka držiaka Al / Square washer for collector support, aluminum	<b>32×32 hr. 8 mm / 32×32, 8 mm thick</b>	2 ks / 2 pcs	<b>9405</b>
	Skrutka M8×50 nerez (imbus) DIN 912/A2 / Socket screw M8×50, stainless steel DIN 912/ A2	<b>M8×50</b>	2 ks / 2 pcs	<b>9982</b>
	Skrutka M8×80 nerez (imbus) DIN 912/A2 / Socket screw M8×80, stainless steel DIN 912/ A2	<b>M8×80</b>	1 ks / 1 piece	<b>11156</b>
	Podložka 8,4 nerez DIN 125/A2 / 8.4 Flat washer, stainless steel DIN 125/A2	pr.8,4 mm / diam. 8,4 mm	7 ks / 7 pcs	<b>7256</b>
	Maticice M8 nerez DIN 934/A2 / M8 Hex nut, stainless steel DIN 934/A2	<b>M8</b>	4 ks / 4 pcs	<b>8381</b>
	Skrutka M8×30 veľká hlava - pre základný profil / M8×30 bolt with big T head, for H-beam	<b>M8×30</b>	2 ks / 2 pcs	<b>8369</b>
	Podložka vejárová - vonkajšie ozubenie 8,4 DIN 6798 A/A2 nerez / Serrated tooth washer, 8.4, DIN6798 A/A2, stainless steel	pr.8,4 mm / diam. 8.4 mm	5 ks / 5 pcs	<b>8382</b>
	Krytka H profilu / H-rail end plug		3 ks / 3 pcs	<b>11773</b>

## Zostavenie držiakov pre slnečné kolektory KPG1, naležato pre šikmé strechy - zvýšenie uhla o 45°.

Assembly of triangle brackets for KPG1 solar collectors,  
for horizontal installations, for sloping roofs - angle  
increase by 45°.

Po rozbalení  
Unpacking

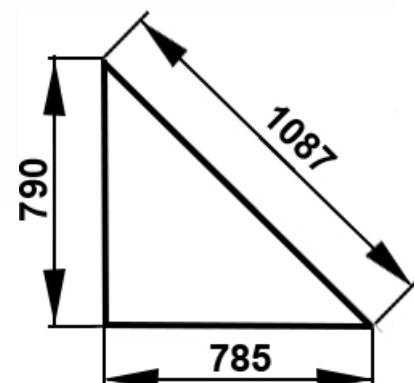

Rozložiť  
Unfolding

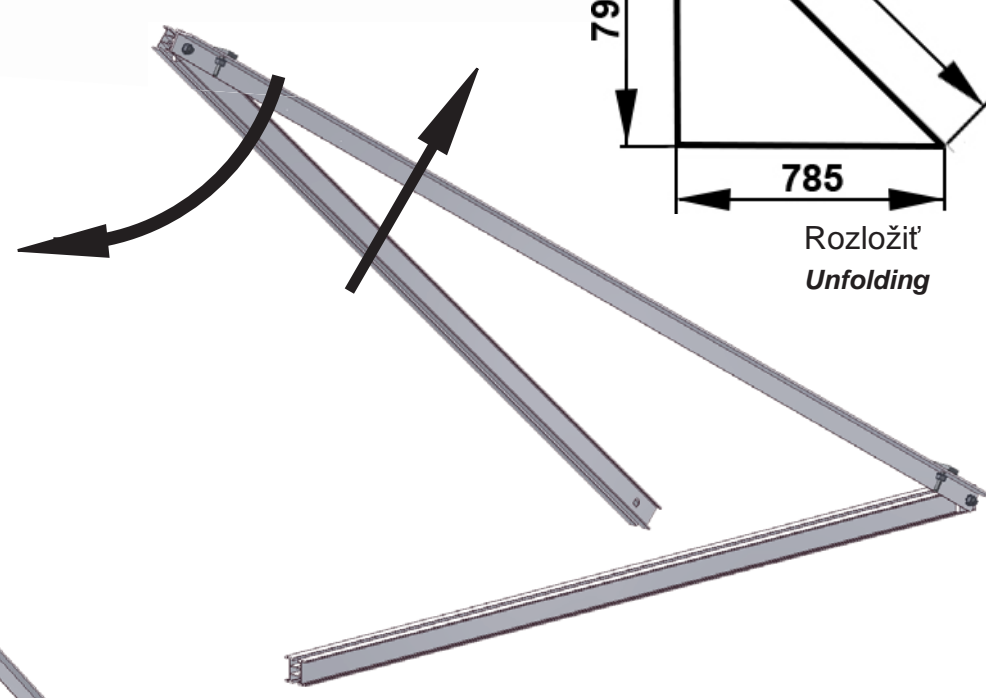

Zoskrutkovať  
Joining together

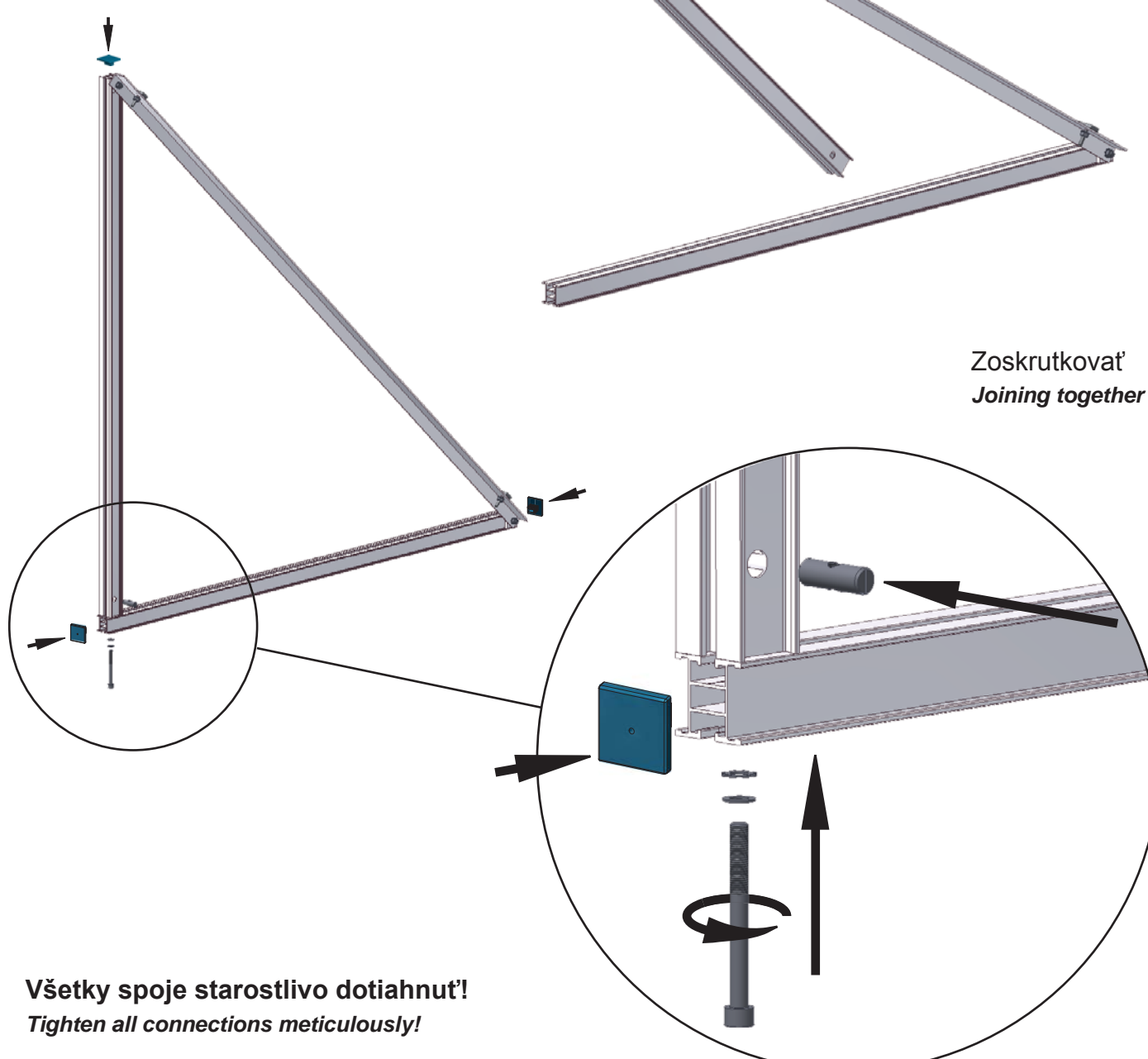

Všetky spoje starostlivo dotiahnuť!  
Tighten all connections meticulously!