







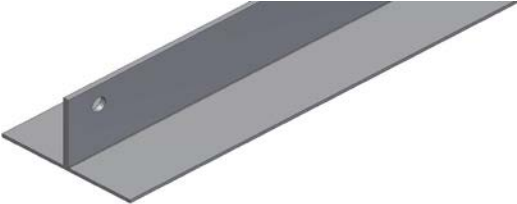

## Držiak pre slnečný kolektor / Support bracket for solar collector

Rovná strecha - trojuholníková podpera 15° kód 11979 / Flat roof - triangle bracket 15° code 11979

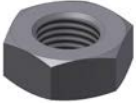
Obrázok Fig.	Označenie Name	Rozmer Dimensions	Množstvo Qty	Kód diela Code
	Profil "L" 30x30x3 hliník / L-beam 30x30x3 in aluminum	Dĺžka 1860 mm / Length 1860 mm	1 ks / 1 piece	<b>9470</b>
	Profil základný "H"-hliník / Basic H-beam in aluminum	Dĺžka 528 mm / Length 528 mm	1 ks / 1 piece	<b>6949</b>
	Profil základný "T" č.12197 - hliník / T-beam no.12197 in aluminium	Dĺžka 1809 mm / Length 1809 mm	1 ks / 1 piece	<b>9469</b>
	Podložka držiaka AI / Square washer for collector support, aluminum	32x32 hr. 8 mm / 32x32, 8 mm thick	2 ks / 2 pcs	<b>9405</b>
	Skrutka M8x45 nerez (imbus) DIN 912/A2 / Socket screw M8x45, stainless steel DIN 912/A2	M8x45	2 ks / 2 pcs	<b>9564</b>
	Skrutka M8x16 nerez (imbus) DIN 912/A2 / Socket screw M8x16, stainless steel DIN 912/A2	M8x16	1 ks / 1 piece	<b>6926</b>
	Matica M8 nerez DIN 934/A2 / M8 Hex nut, stainless steel DIN 934/A2	M8	5 ks / 5 pcs	<b>8381</b>
	Podložka 8,4 nerez DIN 125/A2 / 8.4 Flat washer, stainless steel DIN 125/A2	pr.8,4 mm / diam. 8.4 mm	3 ks / 3 pcs	<b>7256</b>
	Podložka vejárová vonkajšie ozubenie 8,4 DIN 6798 A/A2 nerez / Serrated tooth washer, 8.4, DIN6798 A/A2,	pr.8,4 mm / diam. 8.4 mm	5 ks / 5 pcs	<b>8382</b>
	Skrutka M8x30 veľká hlava - pre základný profil / M8x30 bolt with big T head, for H-beam	M8x30	2 ks / 2 pcs	<b>8369</b>
	Krytka H profilu / H-rail end plug		1 ks / 1 piece	<b>11773</b>

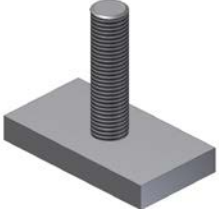
**Zostavenie držiakov pre slnečné kolektory, pre rovné strechy - zvýšenie uhla o 15°.** *Assembly of triangle brackets for solar collectors, for flat roofs-angle increase by 15°.*

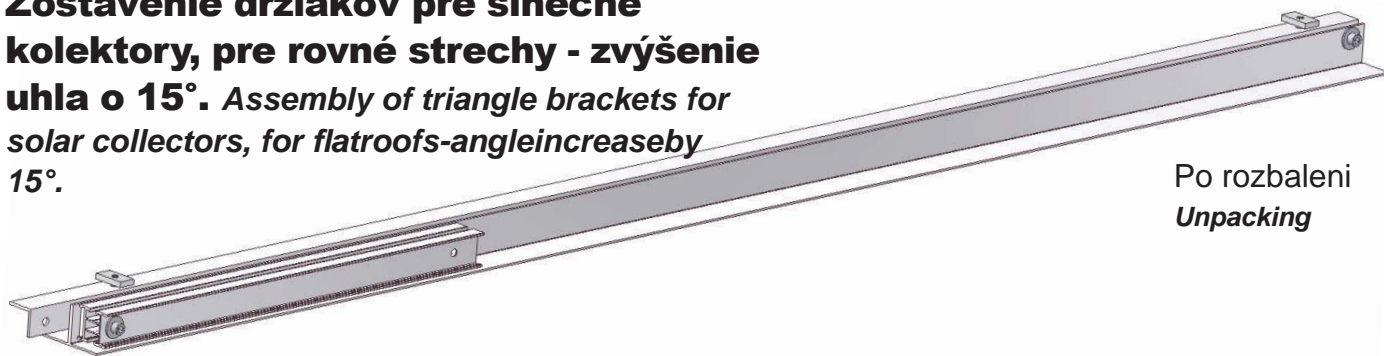

Po rozbalení  
*Unpacking*

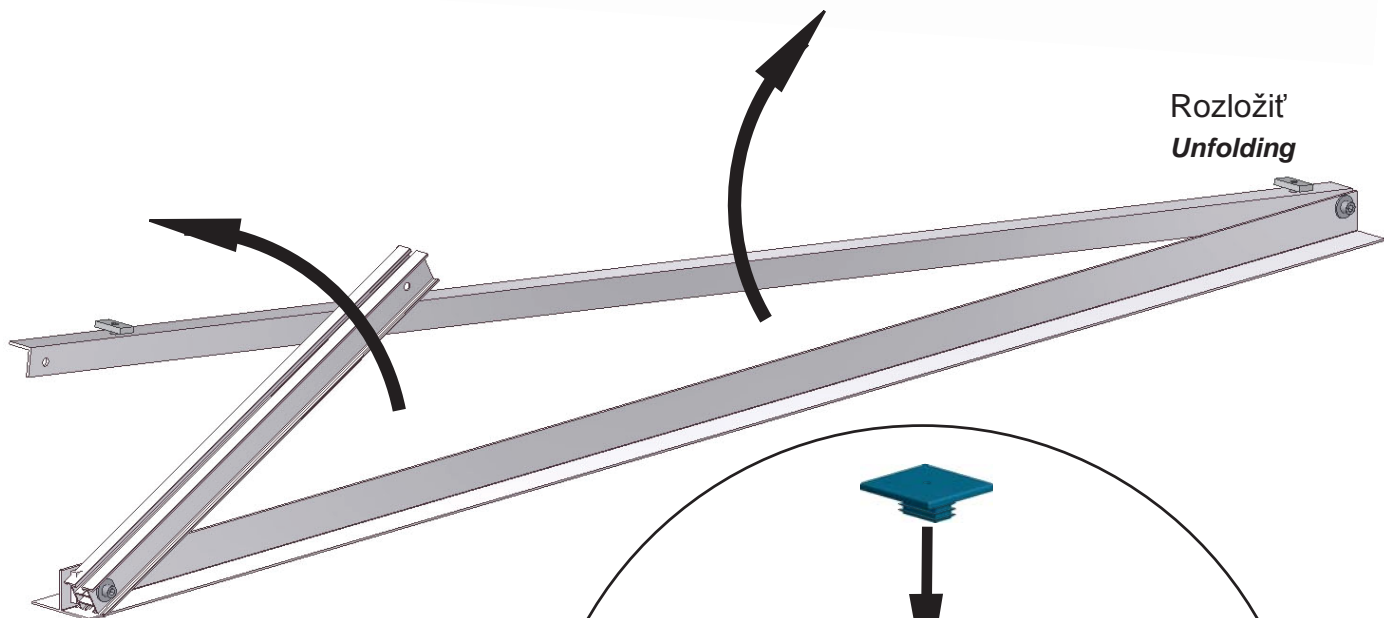

Rozložit'  
*Unfolding*

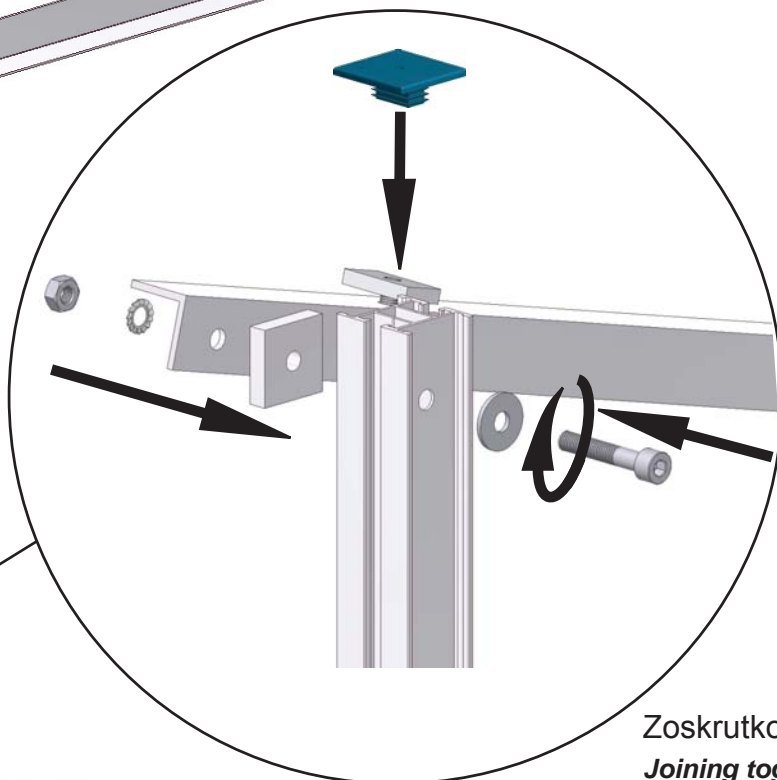
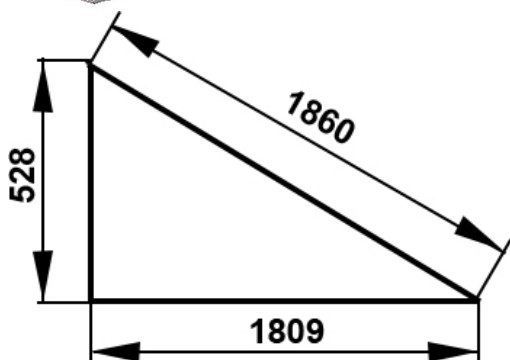

Zoskrutkovať  
*Joining together*

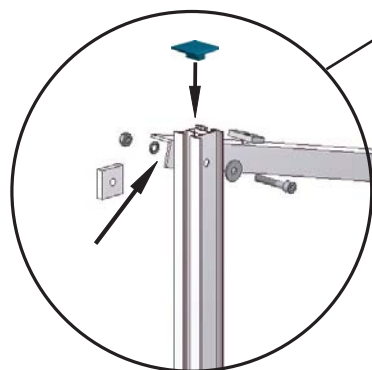

**Všetky spoje starostlivo dotiahnite!**  
*Tighten all connections meticulously!*