

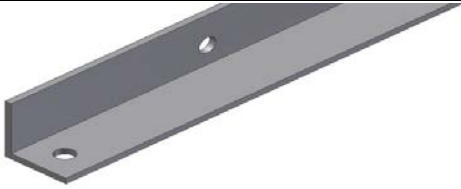







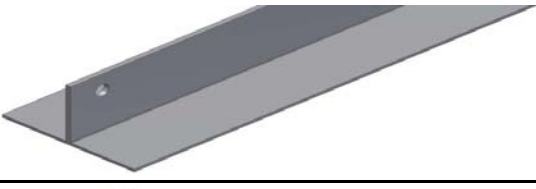
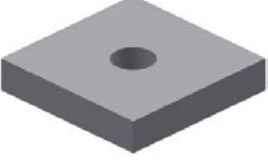

Držák pre snečný kolektor KPG1H naležato

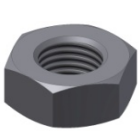
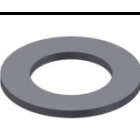
/ Support bracket for KPG1H solar collector, for horizontal installations

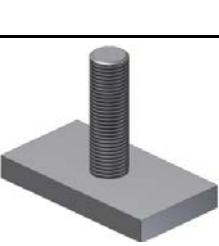
Na stenu - trojuholníková podpera 25° kód 14793 / Wall mount triangle bracke 25° code 14793

Obrázok Fig.	Označenie Name	Rozmer Dimensions	Množstvo Qty	Kód diela Code
	Profil "L" 30x30x3 - hliník / L-beam 30x30x3 in aluminum	Dĺžka 1113,5 mm / Length 1113,5 mm	1 ks / 1 piece	9470
	Profil základný "H"-hliník / Basic H-beam in aluminum	Dĺžka 498 mm / Length 498 mm	1 ks / 1 piece	6949
	Profil základný "T" č.12197 - hliník / T-beam no.12197 in aluminium	Dĺžka 1053 mm / Length 1053 mm	1 ks / 1 piece	9469
	Podložka držiakov Al / Square washer for collector support, aluminum	32x32 hr. 8 mm / 32x32, 8 mm thick	2 ks / 2 pcs	9405
	Skrutka M8x45 nerez (imbus) DIN 912/A2 / Socket screw M8x45, stainless steel DIN 912/A2	M8x45	2 ks / 2 pcs	9564
	Skrutka M8x16 nerez (imbus) DIN 912/A2 / Socket screw M8x16, stainless steel DIN 912/A2	M8x16	1 ks / 1 piece	6926
	Matica M8 nerez DIN 934/A2 / M8 Hex nut, stainless steel DIN 934/A2	M8	5 ks / 5 pcs	8381
	Podložka 8,4 nerez DIN 125/A2 / 8.4 Flat washer, stainless steel DIN 125/A2	pr.8,4 mm / diam. 8.4 mm	3 ks / 3 pcs	7256
	Podložka vejárová - vonkajšie ozubenie 8,4 DIN 6798 A/A2 nerez / Serrated tooth washer, 8.4, DIN6798 A/A2, stainless steel	pr.8,4 mm / diam. 8.4 mm	5 ks / 5 pcs	8382
	Skrutka M8x30 veľká hlava - pre základný profil / M8x30 bolt with big T head, for H-beam	M8x30	2 ks / 2 pcs	8369
	Krytka H profilu / H-rail end plug		1 ks / 1 piece	11773
	Vrut 8x75 nerez (6hr. hlava) DIN 571/A2 / 8x75 Lag bolt, stainless steel, DIN 571/A2	pr.8x75 mm / diam. 8x75 mm	5 ks / 5 pcs	12787
	Podložka 8,4 (veľká 3d) nerez DIN 9021/A2 / Washer 8.4 (large diam. 3d), stainless steel, DIN 9021/A2	pr.8,4 mm / diam. 8.4 mm	5 ks / 5 pcs	7008
	Hmoždinka pr. 12 / Dowel, 12mm	pr.12 mm / diam. 12 mm	5 ks / 5 pcs	11893

Zostavenie držiakov pre slnečné kolektory

KPG1H, naležato 25°, na stenu.

*Assembly of triangle brackets for KPG1H solar collectors,
for horizontal installations 25°, on the wall*

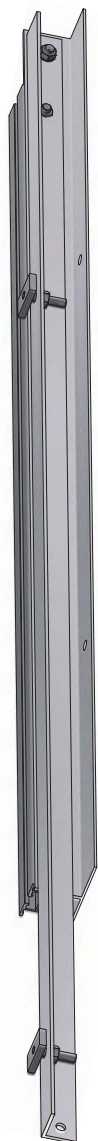

Po rozbalení
Unpacking

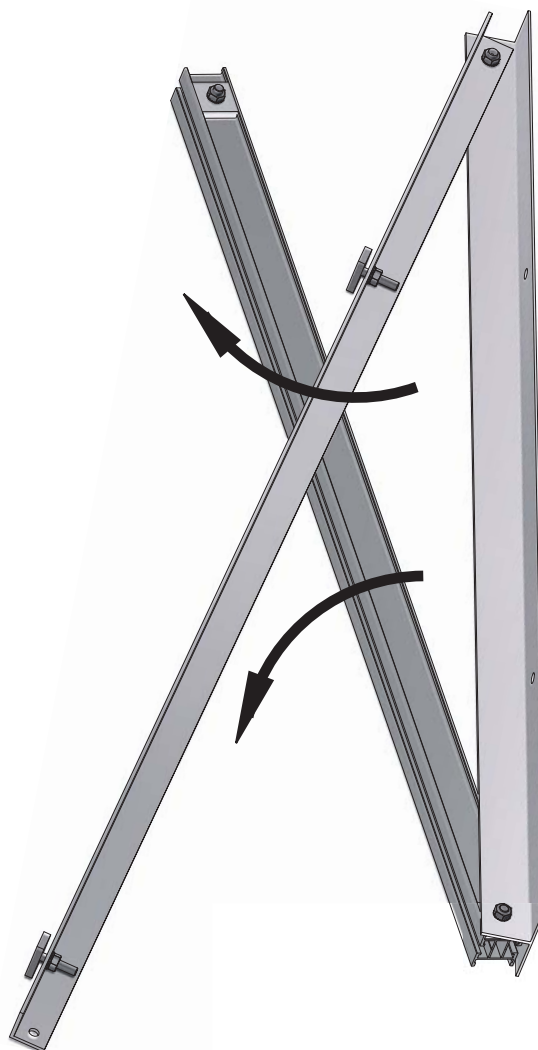

Rozložit
Unfolding

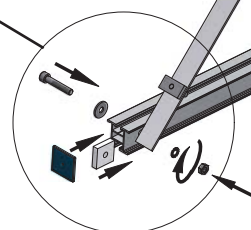
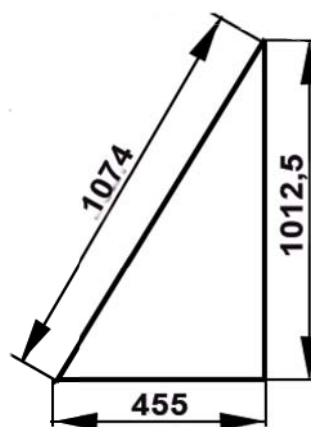
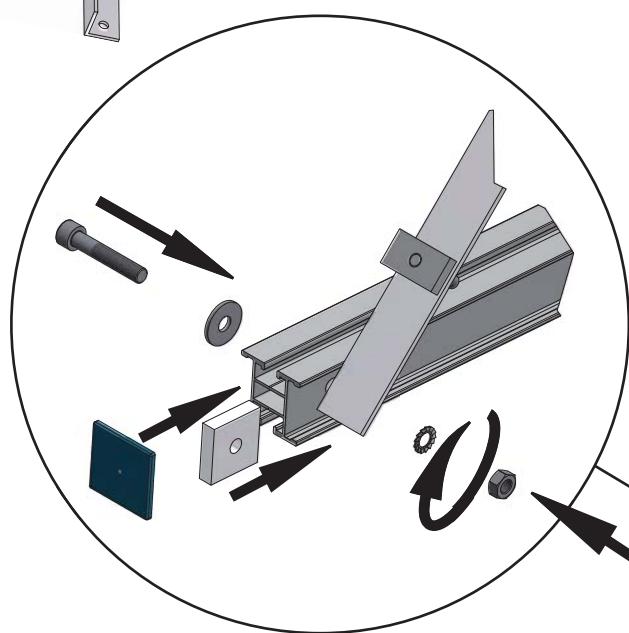

Všetky spoje starostlivo dotiahnuť!
Tighten all connections meticulously!

Zoskrutkovať
Joining together